

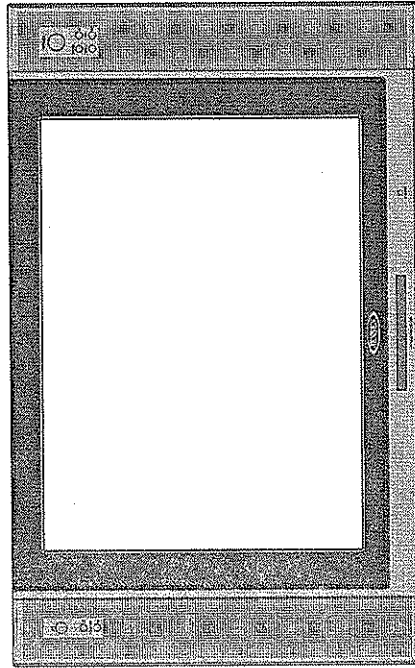

JE2043

OPERATING MANUAL

20" 4:3 DIGITAL LCD-TV



20"

Important Notes :

1. Before operating the unit, please read these instructions carefully.
2. Retain this manual for future reference.
3. Do not remove any WARNING stickers on the unit.
4. You are advised to follow the instructions carefully when operating the unit.
5. Do not use any chemical solvent, cleaning agent or corrosive detergent to clean away dirt on the surface of the screen. By doing so, you may cause irreversible damage to the surface of the TFT screen. To clean off dirt or fingerprints, we recommend the use of a soft damp lens cleaning cloth.
6. Using spare parts from another manufacturer may cause permanent damage to the unit.
7. Install unit in a dry location away from condensation.
8. Ensure no metal or foreign materials are dropped in between the display screen and enclosure.
9. Do not use anything to block the cooling assemblies on the unit.
10. Ensure the plugs are properly plugged in before operating the unit.
11. Should the LCD panel be broken, do avoid all human contact with the broken glass or fluid leaking out from the enclosure. If come into contact, do flush and clean affected areas with plenty of water. Seek medical attention immediately.
12. When operating the display unit, do avoid touching or pressing on the LCD glass panel. Excessive force may cause irreparable damage to the LCD screen.

Safety Precautions:

1. Ensure the plug is securely plugged into the main socket before operating the unit.
2. Ensure the Voltage on the main socket is the same as specified on the unit.
3. Use parts only manufactured by the unit manufacturers.
4. Request a repair report from the technician/service personnel.
5. Ensure the battery is correctly installed before using the unit.

In case of the following emergencies, remove plug from the main socket immediately:

1. Plug or cables are damaged.
2. Any form of foreign objects dropped inside the enclosure.
3. Unit is being exposed to rain and/or water.
4. Unit unable to operate under normal operation.

Notices:

1. The changes or modifications not expressly approved by the party responsible for compliance could void the user's authority to operate the equipment.
2. To comply with the FCC RF exposure compliance requirements, no change to the antenna or the device is permitted. Any change to the antenna or the device could result in the device exceeding the RF exposure requirements and void user's authority to operate the device.

This device complies with part 15 of the FCC RULES. Operations is subject to the following two conditions:

- (1) This device may not cause harmful interference and
- (2) This device must accept any interference received, including interference that may cause undisturbed operation.



CAUTION
RISK OF ELECTRIC SHOCK
DO NOT OPEN

CONTENTS:

1. INTRODUCTION	
Overview	01
Product Specifications	02
Contents/Accessories	03
2. FRONT PANEL CONTROL	
Panel Control	04
Input/Output	04
3. REMOTE CONTROL FUNCTION	
Controls & Functions	05
4. INSTALLATION GUIDE	
When Connecting to a TV Cable	06
Connecting to Other Equipment	07
Input (RCA) from other Equipment	07
Output (RCA) to Other AV Equipment	07
VGA Input	08
Connect Power	08
5. BASIC FUNCTIONS	
Power Signal	09
Mode(SOURCE)	09
Volume Setting	10
Channel Search	10
OSD Setting	10
Mute Setting	11
6. OSD SETTINGS	
Management Setting	12
TV Setting	13
Audio Adjust Setting	14
Picture Adjust Setting	15

CONTENTS:

PC Adjust Setting 16

7. ANNEX A
LCD Maintenance 17

8. ANNEX B
Troubleshooting 18
Common Problems 18

9. SPECIFICATIONS 19

1. INTRODUCTION:

Overview :

New technology in LCD monitors allows the enjoyment of a higher quality picture display and higher brightness; lighter in weight and slimmer body design, power saving capabilities and low radiation, giving you a safe, relaxing and environmental-friendly visual enjoyment.

Our product uses high quality original imported 20 inches 4:3 colored "Active Matrix TFT". The Active Matrix TFT high decoding capabilities enable display of complicated or high quality images, presenting a vivid visual reproduction and beautiful visual display. Incorporated with a user-friendly menu, allowing easy customization to user preferences.

The unit comes with built-in screen display controls when used with the remote control, allowing you to make changes to the settings. It even support the use of 2 channel wireless headphones, therefore you do not need to worry that the volume coming out from the monitor will disturb other people. The Digital True Surround Sound capabilities from the 3D Stereo Speaker brings you the ultimate enjoyment of audiovisual effects. Digital output function, when connected to other audiovisual devices, gives you the best enjoyment in entertainment relaxation.

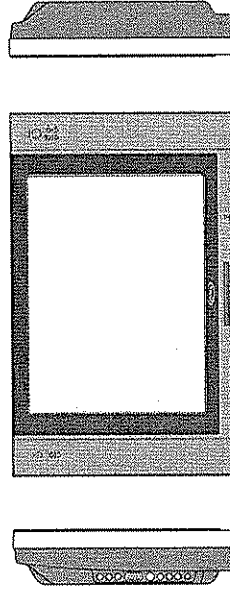

2. Product Specifications:

1. 20" Television / monitor for Mobile use
2. 12V DC Power
3. High Performance, 4:3 LCD Panel
4. High Brightness 500 nit
5. High contrast ratio 500:1
6. Ultra wide viewing angle 170 degrees
7. Front controls
8. Cable ready TV tuner with Closed Caption and V-Chip
9. High output speakers
10. Built in 2 Channel IR transmitter for optional wireless headphones
11. Wireless Night time viewable remote control included
12. Mounting bracket optional
13. Two auxiliary monitor inputs: One fixed NTSC composite, one selectable composite, S-Video or component (HDTV)
14. HDTV ready

Contents/Accessories : (Please check the content of the Package.)

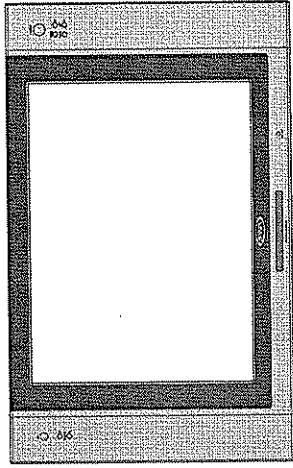

Monitor



Remote Control

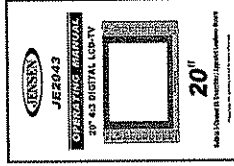

Operation Manual



Component Video Conversion Cable



Composite Video Conversion Cable



RF Connector



Antenna Cable



S-Video Cable

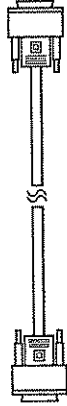

VGA Connect Cable



DC Power Harness 1



DC Power Harness 2



IR Transmitter Audio Input Harness

2. Front Panel Controls:

PANEL CONTROL :

1. POWER : Power On/Off
2. MODE : Mode Select
3. CHANNEL +/- : Channel Select
4. MENU : Menu Setting
5. IR : IR Port for Remote Control

6. VOLUME ⊕ : Increase Volume
7. VOLUME ⊖ : Decrease Volume
8. SPEAKER : Loud Speaker
9. STANDBY : Standby Mode Led

10. IR STEREO TRANSMITTER : For Wireless Headphone

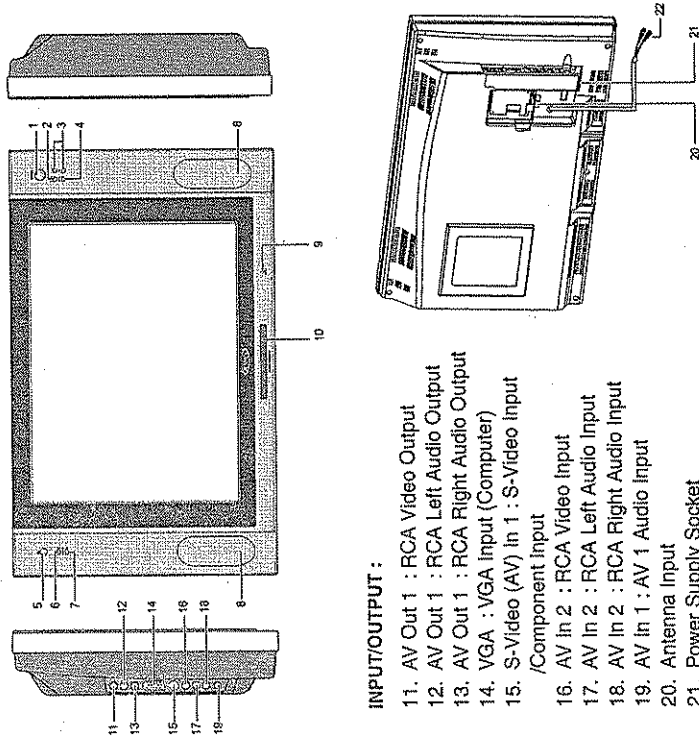

INPUT/OUTPUT :

11. AV Out 1 : RCA Video Output
12. AV Out 1 : RCA Left Audio Output
13. AV Out 1 : RCA Right Audio Output
14. VGA : VGA Input (Computer)
15. S-Video (AV) In 1 : S-Video Input /Component Input
16. AV In 2 : RCA Video Input
17. AV In 2 : RCA Left Audio Input
18. AV In 2 : RCA Right Audio Input
19. AV In 1 : AV 1 Audio Input
20. Antenna Input
21. Power Supply Socket
22. Second IR Transmitter Audio Input

3. Remote Control Function :

(When using the remote control, point it towards the IR sensor.)

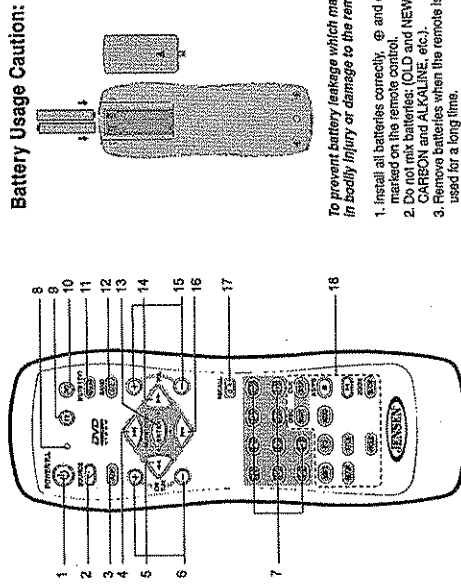

Battery Usage Caution:

To prevent battery leakage which may result in bodily injury or damage to the remote :

1. Install all batteries correctly, ⊕ and ⊖ as marked on the remote control.
2. Do not mix batteries (OLD and NEW or CARBON and ALKALINE, etc.).
3. Remove batteries when the remote is not used for a long time.

Note: 1. Some buttons on remote have two functions (for TV & DVD mode). When press the TV button, the remote will get into TV function mode, each time when press the TV function button, the LED will flash "RED" light. When in DVD Mode, each time when press the DVD function button, the LED will flash "GREEN" light.

2. Some of the buttons are designed for operate single disc DVD player, pls read the DVD manual to operate the DVD player.

TV Mode:

1. POWER : Power On/Off
2. SOURCE : Signal Button
3. AUTO PROGRAM : Channel Scanning
- 4./5./14./16. ▲ /◀ /▶ /▼ : Up, Down, Left, Right Button for setting
6. CH (+/-) : Channel Up/Channel Down
7. 1/2/3/4/5/6/7/8/9/0 : Numbers Button
8. LED : TV Mode --- Red Flash ; DVD Mode --- Green Flash
9. TV : TV Mode Selected
11. MUTE(TV) : TV Mute Button
13. ENTER : Enter Button
15. VOLUME (+/-) : Volume Up/Volume Down
17. RECALL : Channel Return

DVD Mode:

4. NEXT TRACK (▶▶) : Select Next Title/Chapter
5. FR (◀) : FAST Reverse Play
10. DVD : DVD Mode Selected
11. FF (▶▶) : FAST Forward Play
12. MENU : DVD Root Menu Title/Chapter
16. PREVIOUS TRACK (◀◀) : Select Previous Title/Chapter
18. DVD Button : Buttons only for DVD use

4. INSTALLATION GUIDE:

When Connecting to a TV Cable:

1. Remove Antenna Socket cover.
2. Plug the cable to the input socket on the unit.
3. Connect the cable that comes along with the unit to the one you are using when needed.

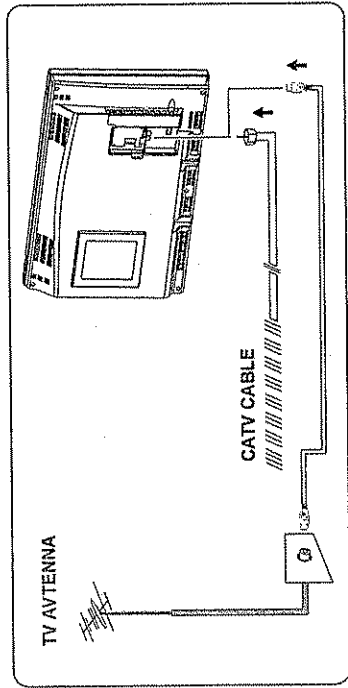

Connecting to Other Equipment :

1. This unit is able to support various input setting. You can connect your video recorder, amplifier, game console etc, to the unit, to enjoy high quality, digital audio-visual effect.
2. Connect AV equipment using S-Video. (photo.1)
3. Using the S-Video cable, connect your equipment to the S-Video/Component socket on the TV Side Input Panel.
4. Connect your AV cable to the equipment. (photo.2)

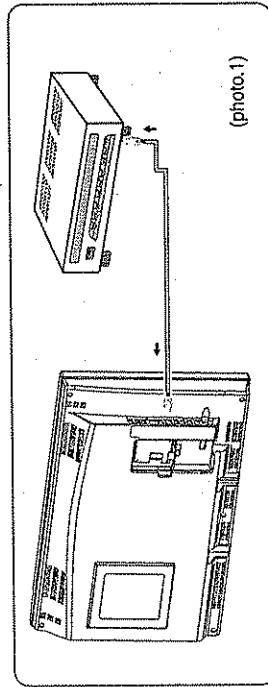

Noted: When connect S-Video input, please set OSD (AV1 Select) to "SV" to view S-VIDEO source.

08

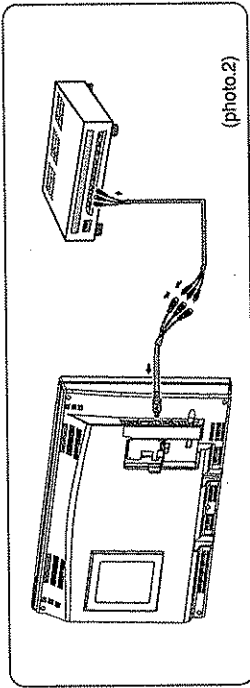

(photo.2)

Noted: When connect Component Video input, please set OSD (AV1 Select) to "CV" to view Component-Video source.

Input (RCA) from other Equipment:

Connect to the TV AV IN 2 socket.

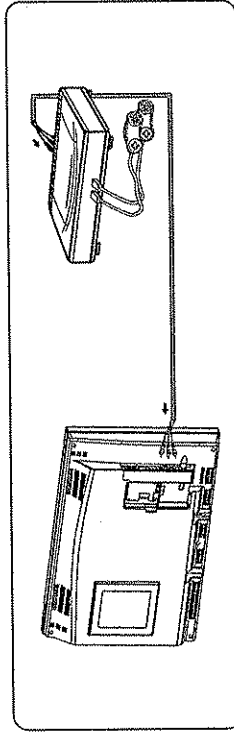

Noted: When connect AV IN 2, please set OSD (AV1 Select) to "AV" to view AV IN 2 source.

Output (RCA) to other AV Equipment:

Output the AV Signal using the unit AV output socket.

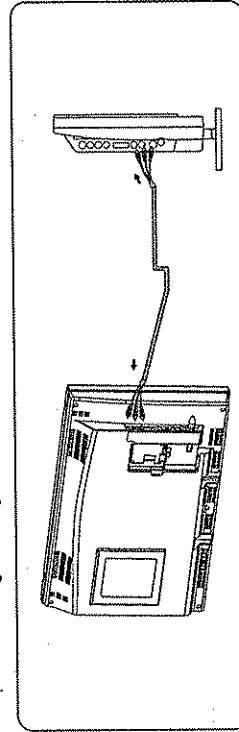

Noted: When connect AV OUT 1, please set OSD (AV1 Select) to "AV" to view AV OUT 1 source.

07

5. Basic Functions :

* POWER SIGNAL:

1. When POWER Indication LED on unit turns RED in color indicating power is connected.
2. Press the "Power" button on the remote control, the POWER indication LED on the TV Front Panel will turn "GREEN in color".

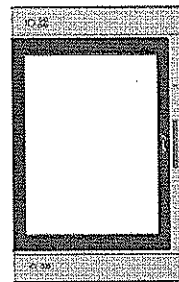
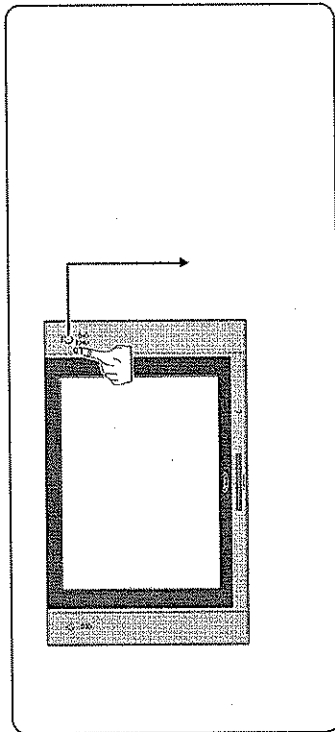

* VGA Input:

This unit provides VGA (Computer) input connector.

1. Connect computer VGA output to the monitor VGA input using VGA cable.
2. To connect audio source, using audio cable to connect from computer audio output to VGA audio input.

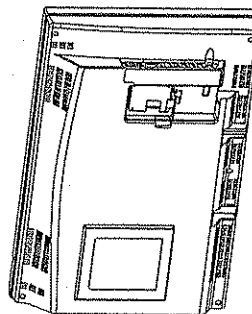
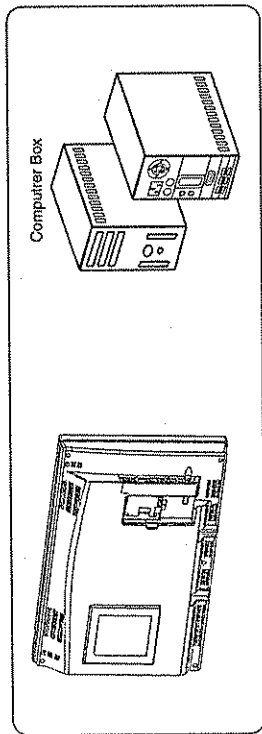

*** Volume Setting:**

1. Press "Volume +/-" (▲/▼) button on TV front control panel or remote control to adjust volume level.

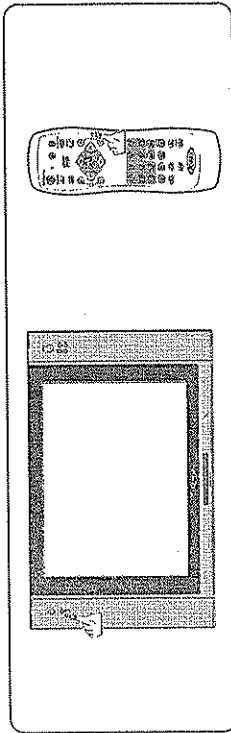

*** Channel Select:**

1. Press "Channel ▲/▼" button on remote control or TV Front Control Panel to change/select channels.
2. Press on Number buttons on remote control to change/select channel directly.

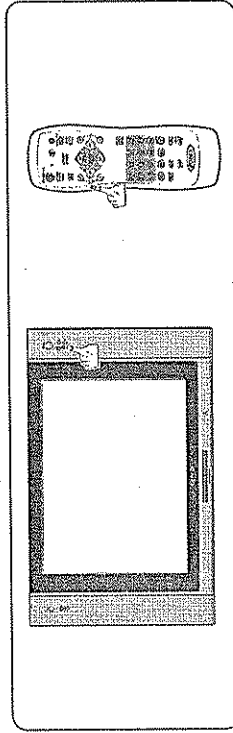

*** OSD Menu Setting:**

This monitor provide "OSD" setting, enable you to customize the setting for monitor. Press "MENU" button on remote or front control panel to set OSD menu.

Note: Before adjust settings, ensure all the video source is in correct mode.

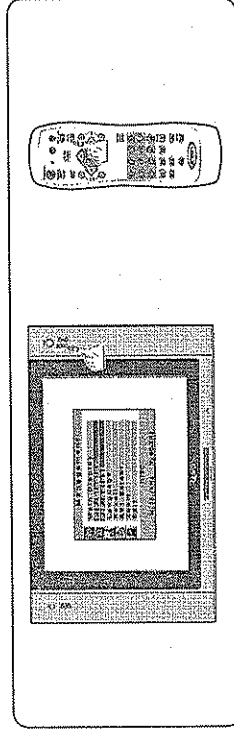

*** Mute:**

1. Press "MUTE" button on remote control to mute speakers. "MUTE" will display on screen.
2. Press "MUTE" button again or "Volume +/-" button to return sound back to speakers.

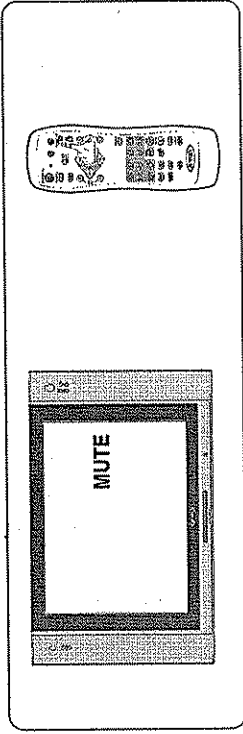

6. OSD Settings:

This monitor provide "OSD" setting, enable you to customize the setting for monitor.
 Note: Before adjust settings, ensure all the video source is in correct mode.

Management Setting :

Press "MENU" button, osd menu will display on screen, press "SET" / " " button to select "TV setting", and press "ENTER" button to enter management setting, then press "SET" / " / " select course settings. (Pls see chart as below)

TV Setting :

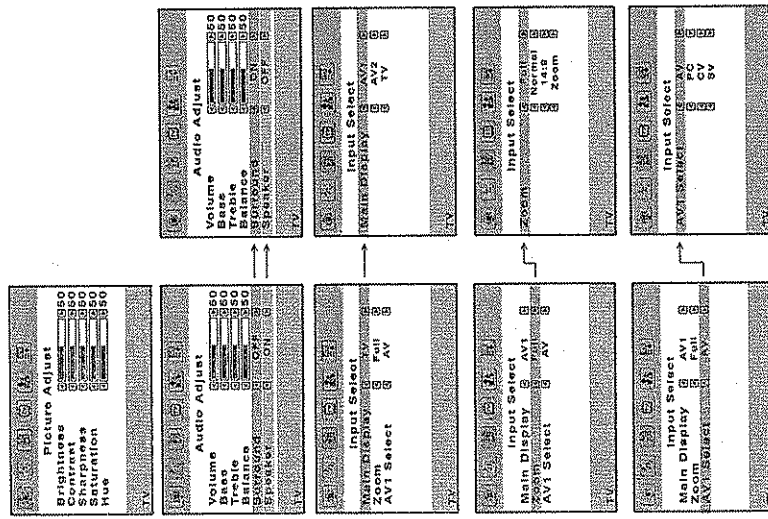

TV Setting :

Press "MENU" button, osd menu will display on screen, press "SET" / " " button to select "TV setting", and press "ENTER" button to enter TV setting, then press "SET" / " / " select course settings. (Pls see chart as below)

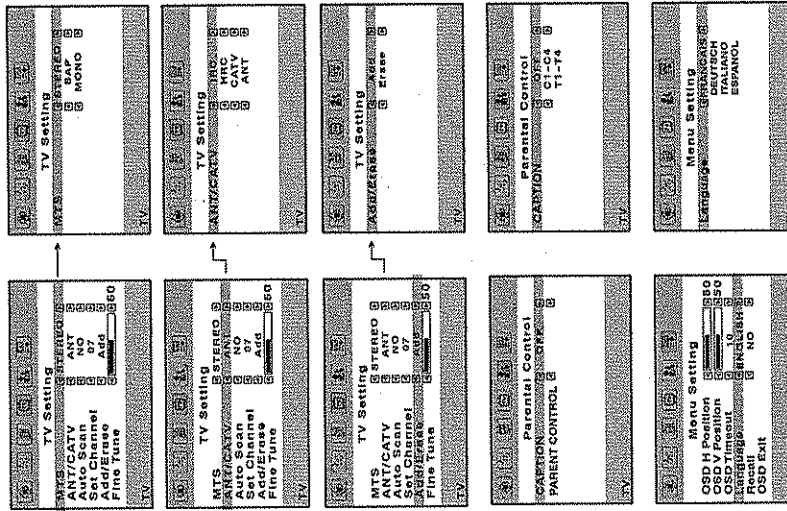

6. OSD Settings:

This monitor provide "OSD" setting, enable you to customize the setting for monitor.
Noted: Before adjust settings, ensure all the video source is in correct mode.

Management Setting :

Press "MENU" button, osd menu will display on screen, press "SET" button to select "AV1 setting", and press "ENTER" button to enter management setting, then press "SET" button to select course settings. (Pls see chart as below)

AV1 Settings:

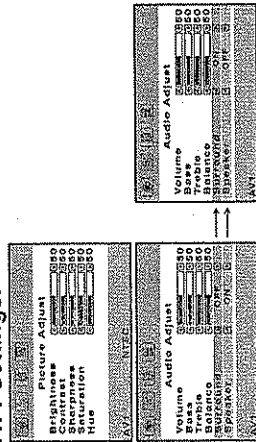

7. OSD Settings:

This monitor provide "OSD" setting, enable you to customize the setting for monitor.
Noted: Before adjust settings, ensure all the video source is in correct mode.

Management Setting :

Press "MENU" button, osd menu will display on screen, press "SET" button to select "AV1 setting", and press "ENTER" button to enter management setting, then press "SET" button to select course settings. (Pls see chart as below)

AV2 Settings:

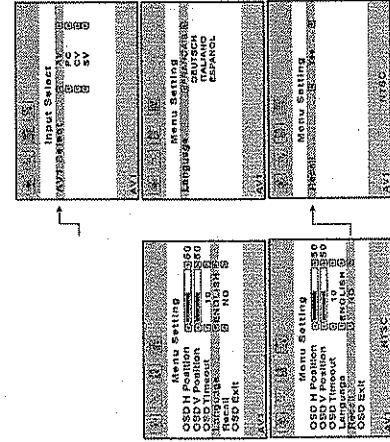

6. OSD Settings:

This monitor provide "OSD" setting, enable you to customize the setting for monitor.
Note: Before adjust settings, ensure all the video source is in correct mode.

Management Setting :

Press "MENU" button, osd menu will display on screen, press "SET" button to select "Management setting", and press "ENTER" button to enter management setting, then press "SET" select course settings. (Pls see chart as below)

PC Settings:

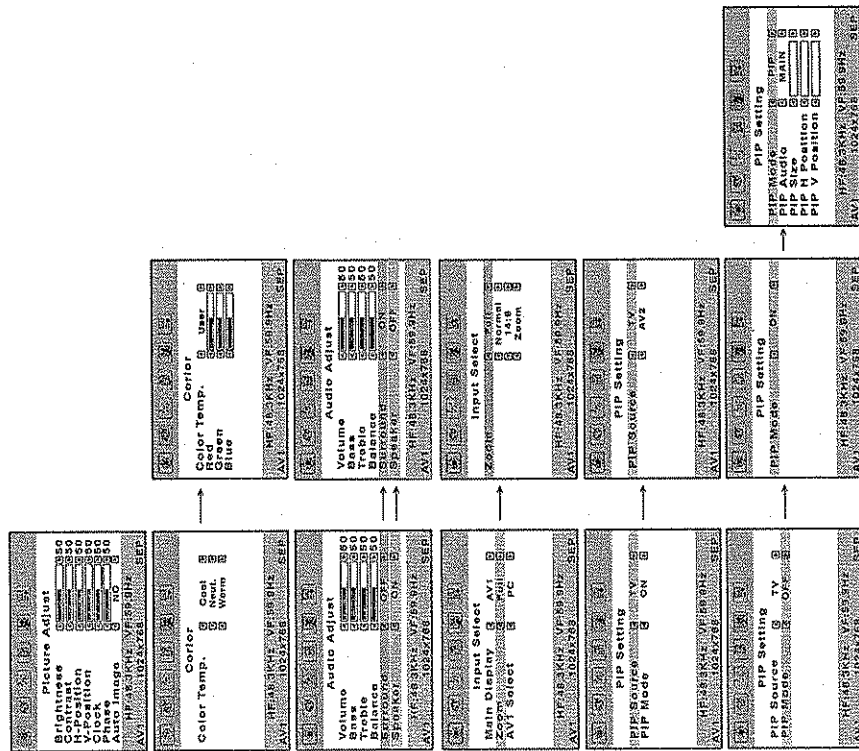

OSD Settings:

Management Setting :

Press "MENU" button, osd menu will display on screen, press "SET" button to select "Management setting", and press "ENTER" button to enter management setting, then press "SET" select course settings. (Pls see chart as below)

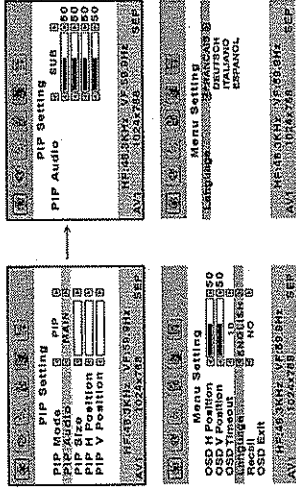

7. ANNEX A:

LCD Monitor Care & Cleaning Tips:

To avoid possible shock hazard, be sure the LCD TV is turn off and unplugged from the main electrical outlet before cleaning.

Do not use any form of solvents on the LCD monitor.

Cleaning the LCD Monitor:

1. Use a soft, clean & dry cloth to gently wipe off the dust on the LCD monitor.
2. Use a clean cloth dampened with water to wipe off the dirt.
3. Do not exert force when cleaning the LCD monitor.

Cleaning the Enclosure:

1. Use a soft, clean & dry cloth to gently wipe off the dust on the LCD monitor.
2. Use a clean cloth dampened with water to wipe off the dirt.
3. Do not exert force when cleaning the LCD monitor.

8. ANNEX B:

Troubleshooting:

If the unit fails to operate normally, try solving the problems using the guide below. If the problem persists, switch off the unit and ask the dealer or customer services officer for assistance. Do not attempt to repair the defective unit yourself. Do not endanger yourself as high voltage is involved.

1. No Picture:

- Check that the power cord is plugged into the main socket and the power supply is turned on.
- Check the contrast and brightness setting.
- Check the Antenna connection to see if it is properly connected to the LCD-TV Input Terminal.
- Be sure you have selected the correct source mode.

2. Snowy Picture:

- Check to see if the Antenna is correctly connected.
- Check to see if the picture setting is correctly set.

3. Picture Flickers:

- Check that the power coming from the main socket is sufficient.
- Check that unit is not placed too near speakers or magnetic objects.
- Check to see that the unit setting is correctly set.

4. No Sound:

- Check that mute function is off.
- Increase the volume.

5. Remote Control not Working:

- Check batteries are installed correctly, replaced if necessary.
- Aim the remote controller towards the unit remote sensor.

6. Unit will not power on w/ front Power button:

- Check the power is connected.
- Power indication LED on unit is red in color.

9. SPECIFICATIONS:

Panel Type	Active Matrix LCD-TFT
Display Size	20" (Diagonal)
Aspect Ratio	4:3
Resolution	307,200 Pixel (640x480)
Display Colors	16.7 M
Luminance	500 cd/m ²
Contrast Ratio	500 :1
View Angle	H: 170 degrees, V: 170 degrees
TV-System	NTSC
Speakers	2 x 5W
Audio DAC	96 kHz/24-Bit Audio-D/A-Converter
Inputs	1x (S-Video/Component/CVBS Input <Mini-DIN>), 1x VGA Input, 1x AV-IN (RCA)
Outputs	1x AV-OUT (RCA)
IR-Transmitter	Channel 1: 2.3Mhz/2.8Mhz, Effective Angle:45° Effective Range:12 Feet Channel 2: 3.2Mhz/3.8Mhz, Effective Angle:45°
REMOTE RANGE	Effective Range:12 Feet
OSD-Language	English, Frangaic, Declsch, Espanol, Chinese
Accessories	NTSC; Antenna / Cable Monitor/Operating Manual, Remote Control, Antenna Cable, Component Video Conversion Cable, DC Power Harness, Composite Video Conversion Cable, VGA Connector Cable, RF Connector, IR Transmitter Audio Input Harness

Noted: All specifications are subjected to change without prior notification



asaelectronics.com